



# User Manual



As fitted to

## **METALMASTER MACHINES**

Models

**PB-40A** (S970F)

**PB-70B** (S902F)

**PB-135B** (S906F)

**PB-135B** (S908F)

**PB-170B** (S910F)

**PB-200B** (S912F)

# Fasfold Help Manual

---

## Contents

1. Alter between 2 display modes .....	2
2. Enter a job using the data entry method.....	3
3. Draw a new Job using Quick draw .....	4
4. Editing sizes and angles.....	4
5. Select Tools from the library.....	5
6. Select Dies from the library.....	6
7. Step through job and find collisions .....	7
8. Alter the Bend Sequence .....	7
9. Find collisions .....	8
10. Select correct V width .....	8
11. Set Material Thickness and width .....	8
13. Run job without material .....	9
14. Correct under or overfolding .....	9
15. Name a Job.....	10
16. Save a Job.....	10
17. Open a Job .....	11
20. Box Mode .....	12
21. QuickDraw Advanced .....	14
22. Change Tensile strength correction .....	14
23. Program and save a new tool .....	15
24. Program and save a new die .....	16
26. The Calibrate screen .....	17
27. Calibrating the Port.....	18
28. Calibrate Servo Drives .....	19
29. Calibrate PLC .....	21
30. Calibrate Machine .....	23
31. Calibrate Program .....	24



## 2. Enter a job using the data entry method

On the left half of the screen is the Data entering area.

1	10	90	0	105.61	90
2	15	90	0	105.61	90
3	-15	-90	0	105.61	90
4	-50	-90	0	105.61	0
5	90	-90	0	105.61	0
6	50	-90	0	105.61	0
7	-15	90	0	105.61	0
8	-15	90	0	105.61	0

If the profile is displayed, press the mode button to change from the profile display to the numerical data block.

The data block is divided into 5 vertical columns from left to right.

From left to right is the dimension, angle, trim angle, tool depth and retract columns.

From top to bottom is the bend numbers of the profile from 1 to the total number of folds plus one. This is because any profile has one more side than folds. The last dimension will not have an angle.

1. Press on the top left hand cell, column 1, row 1. On the pop-up keypad, press "0" and "OK"

This will clear the whole data field.

2. Enter the first length 50

3. Enter the first angle 90

4. Enter the second length 150

5. Enter the next angle 90

6. Repeat steps 4&5 until all bends is entered.

7. Enter the last length 50

As you go along, the profile is drawn on the right so you can see what it looks like. If a certain bend is on the wrong side of the material, change the sign of the angle to a negative for that bend. For example if you draw a 2 bend profile as a U shape but you need a Z shape, change the angle for bend 2 to negative. This means that the work piece will have to be turned over from top to bottom. In the above example bend 1 & 2 is done on the top side (U shape). Change bend 2 to -90 to change to Z shape.

### 3. Draw a new Job using Quick draw

Press the Quickdraw button and the following screen will appear.

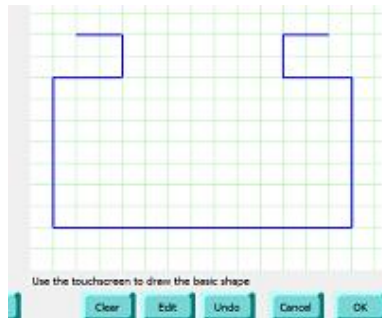

Starting from the top left point of the profile above, touch the screen approximately on each corner where you would like each bend to be, the points will automatically snap to the grid and the values are rounded off. Press **UNDO** to redo a bend

**Undo** Removes last bend

**Cancel** Exit without using current Shape

Advanced use of Quickdraw can be found in section 21.

When you are happy with the shape press **OK** and you will be returned to the main screen, where you can fine-tune the values easily simply by touching on the dimension or angle to be altered.

### 4. Editing sizes and angles

Touch on any dimension or angle on the profile and enter the new value on the pop-up keypad.

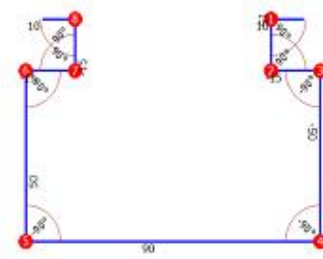

## 5. Select Tools from the library

Touch on the top tool graphic on the main screen to go to the tool screen.

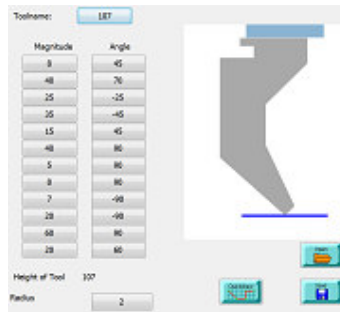

On this page, a new tool can be drawn up, named and saved. This is discussed in section 23. To select a different tool from the library, press open.

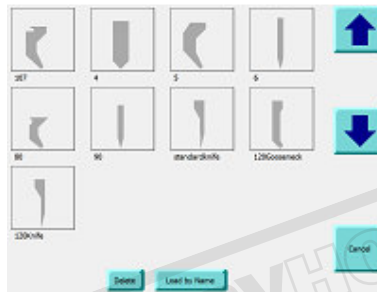

Select the desired Tool. If there are more tools than one page, use up and down arrow.

Press CLOSE to return to Main page

### 6. Select Dies from the library

Press on the die (bottom tool) graphic on the main screen to go to the Die screen.

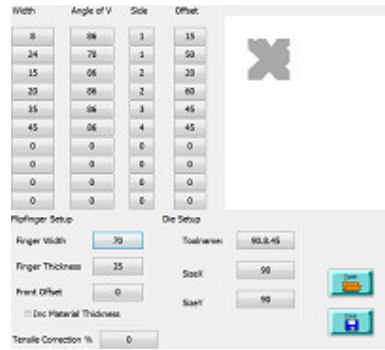

On this page, a new Die can be created, named and saved as discussed in section 24. To select a different Die from the library, press open.

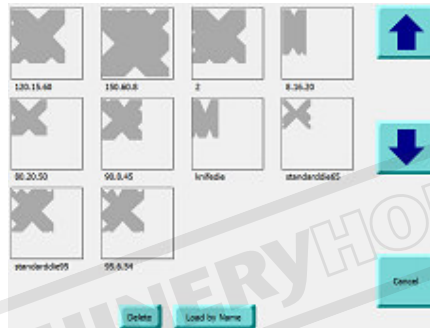

Select the desired Die. If more Dies than one page, use up and down arrow.

Press cancel, then close to return to Main page.

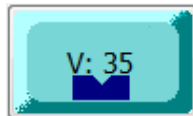

Press on the V button to select the desired V (Material thickness X 8)

## 7. Step through job and find collisions

Press on the bend sequence numbers (**Seq**) below the graphic one after the other from left to right and see how it will fold up and whether there are any collisions. As you step through the numbers, the folding will be animated on the graphic

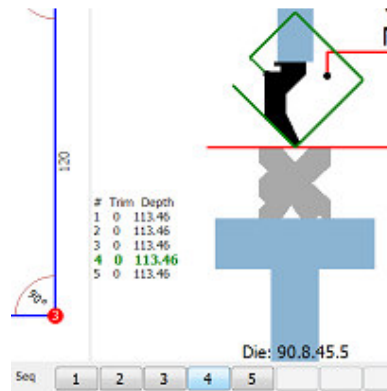

## 8. Alter the Bend Sequence

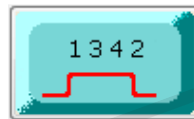

Press the bend sequence button to go to the bend sequence page

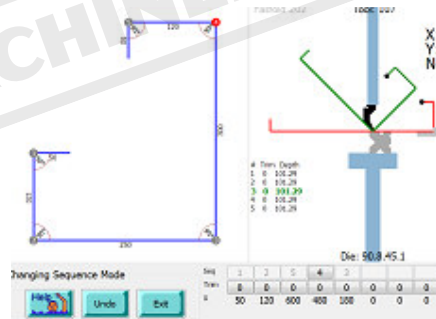

Touch on the first bend (red dot on profile), it will turn grey, then the next bend and the next until complete. As you go along, you can see on the right how it would be folding. If the wrong bend is selected, use the UNDO button. Alternatively, enter the bend sequence by pressing on the bend numbers below the profile. Screen returns to main automatically after last bend entered.

## 9. Find collisions

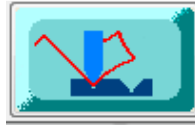

**Warning:** If a bend sequence has been set before, it will be lost when pressing the Collision button. The collisions button will automatically step through bends as if a collision is found, it will alter the bend sequence in an attempt to avoid collisions.

Press the collisions button and it will attempt to find an alternative bend sequence automatically if the default 1,2,3,4 creates a collision.

If it finds a workable bend sequence, it does not mean it will be the best or the fastest. A manual bend sequence can be set in section 8

## 10. Select correct V width

Pressing the V button will toggle between the different V's on the current Die

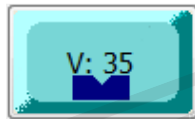

## 11. Set Material Thickness and width

Use the 2 buttons below to enter the correct thickness and width.



### 13. Run job without material

After downloaded a job, press START for the machine to position. While X&Y axis (Ram- and Backgauge) is positioning, a bar graph indicates while it is positioning



When in position, the bar graphs disappear and the machine is ready to fold. The X and Y values in the top right hand corner will turn from red to green. Without inserting material, use the foot switch to execute the folds until all folds are completed and the press is ready for the first fold. Observe between every fold that the machine is positioning correctly.

Fold up the job with actual material. Check angles.

### 14. Correct under or overfolding

The third column from the left is the angle trim column. If a fold is 5 degrees under, enter 5 into the appropriate cell

If it overfolds, enter -5.

1	50	90	3	108.89	0
2	120	90	-2	108.25	0
3	250	90	0	108.5	0

Look at the difference in Tool-depth column

(4<sup>th</sup> from the left) Fold 3 is a 90d

Fold 3 0 trim depth = 108.5

Fold 2 -2 trim = 108.25

Fold 1 +3 trim = 108.89

If the trim values is generally all high, lets say 8 degrees on average, it can be because the tensile strength is different or maybe the V width is slightly larger than measured. It is then better to change the tensile strength correction on the Die screen and use no or small trim values. Refer to section 22.

## 15. Name a Job



Press the Job name button and enter the job name on the popup keyboard below.



Bottom left is a button that switches between QWERTY style and ABC style.

Press OK when finished.

## 16. Save a Job

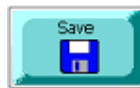

Press SAVE and you will be prompted if you want to overwrite the current job. Press YES and it will ask for a password - enter 159.

MACHINERYHOUSE

## 17. Open a Job



Press OPEN and select a job from the list

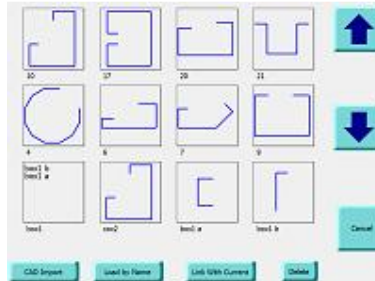

You can also import a DXF file generated by a CAD program like Autocad, SolidEdge, SolidWorks, Autodesk Inventer etc.

Press CAD Import to do this and select a job or change directory or select the office computer if utilising a network.

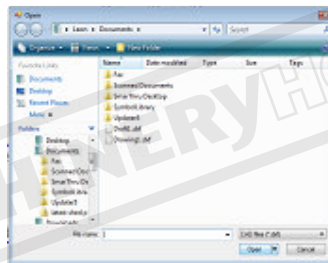

Select the DXF file and press open. It will return with the new job on the Fasfold main screen.

## 20. Box Mode

Lets program the box below.

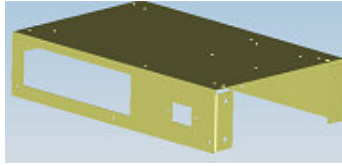

Use QuickDraw to draw the Front view of the box above.

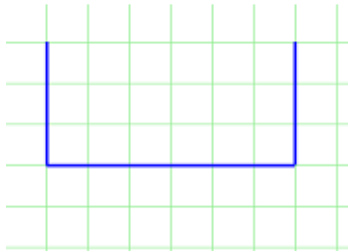

Edit the sizes on the profile on the main screen as described in section 4.

Set the right tooling, material thickness, width, bend sequence, name it Box1 a and save. Get the right tooling on the machine and test fold the job to make sure the tooling is correct (alter trim angles if necessary) and save.

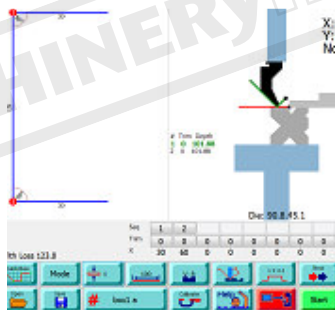

Now draw up the side view and name it box1 b.

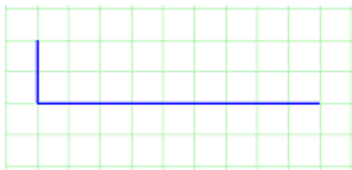

Edit the sizes on the profile on the Main screen. Get the right tooling on the machine and test fold the job to make sure the tooling is correct and save.

Now link the 2 jobs together by pressing open, Link with current and press on box1 b if box1 a is open already. If box1 b is already open, then link and open box1 a.

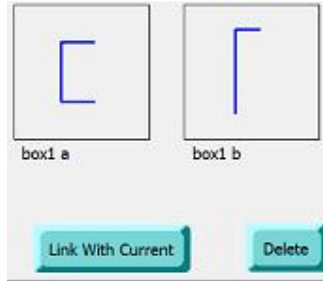

If you press on the Box button below, it will toggle between A & B and the job will switch between the front and side elevation on the profile and graphic.



Press Download and run the job. After the last fold on the A side, it will automatically switch to the B side on the screen and position.

You can save this linked job as a complete job by pressing SAVE, and LINKED on the window. This will save time in future linking 2 jobs



When you press OPEN, previously linked jobs will be displayed as below left

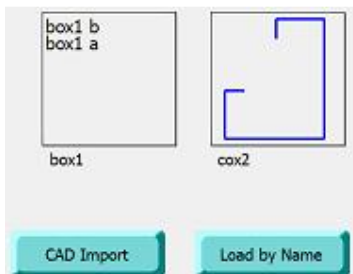

## 21. QuickDraw Advanced

If you would like to modify or edit a job you busy drawing up, there are a number of options:

**Grid Size:** The size of the grid squares

can be altered by changing the value in

the bottom left corner.

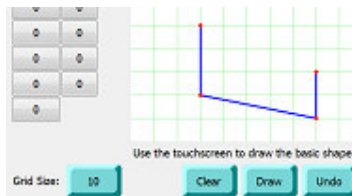

**Edit:** After pressing this you can see red dots

On each corner, press one you want to move

and it will highlight then press again to the

point you want to move it.

**Undo:** This will undo the last action.

**Clear:** Deletes all data and start again

## 22. Change Tensile strength correction

If large trim values are necessary due to tensile strength, enter a percentage tensile correction on the DIE screen.

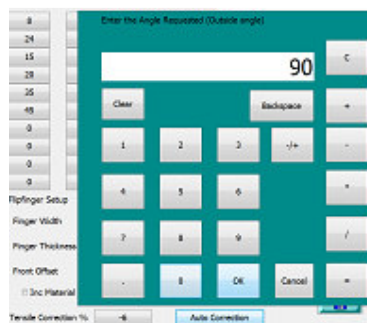

You can either directly enter a percentage by pressing on the Tensile correction button and enter on the popup keypad or press Auto Correction, enter the desired angle as prompted and then resulted angle. It automatically enters a tensile correction. When a job is saved, it saves the tensile correction for that job.

## 23. Program and save a new tool

From the Main screen, press on the top tool graphic which will take you to the Tool screen. From there press QuickDraw which takes you to the Tool Quickdraw screen.

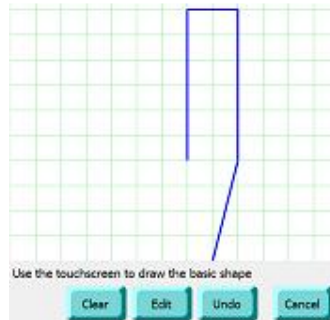

Starting from the bottom in a anticlockwise

direction, touch on each of the approximate corners to get the basic shape drawn.

The end point of the tool should be touched in the same spot as the start point to complete the tool. Press UNDO if you make a mistake. Press OK to return to the Tool screen. You will be prompted for the tool height. Enter this as the height from tool tip to the shoulder of the tool.

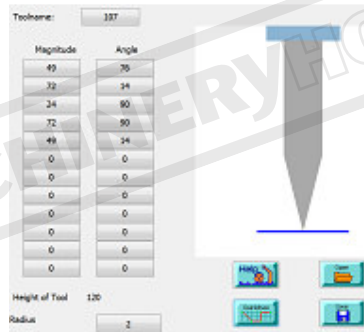

Actual sizes can now be edited on the data area on the left. Enter the radius of the tool, give it a name and save.

## 24. Program and save a new die

Press on the bottom DIE on the graphic to go to the DIE screen.

Width	Angle of V	Side	Offset
8	86	1	15
24	70	1	50
15	86	2	20
20	86	2	60
35	86	3	45
45	86	4	45
0	0	0	0
0	0	0	0
0	0	0	0
0	0	0	0

Fingering Setup		Die Setup	
Finger Width	70	Toolname:	90.8.45
Finger Thickness	35	SizeX	90
Front Offset	0	SizeY	90
<input type="checkbox"/> Inc Material Thickness			

Type the overall dimension of the tool as SizeX and SizeY.

Now use the Data area on the left to enter the V sizes etc.

Before actually programming the new Die, lets use the above example to explain the Data area. The first column contains all the V sizes, 8,24,15,20 etc.

The next column contains the Angle for each V 86,70,86 etc.

The next column is the side number on the block. Top side is side1, then 2,3 & 4 in a clockwise direction. To enter a side number, press on it and it will toggle from 1 to 4. It will not bring up a keypad.

The last column is the offset which is the distance from the left edge to the centre of the V, 15,50,20,60 etc.

Now clear the whole data field by entering a zero into the top left cell.

Measure the V width of the first V and enter in line one, then angle, then side one, then the distance from the left edge of the DIE to the centre of the V.

Now do the same for all the V's

Name the Die and Save.

Tip: Use descriptive names such as 95.8.48 so it can be easily identified in future. 95 indicates height, smallest V is 8mm and largest is 48mm.

## 26. The Calibrate screen

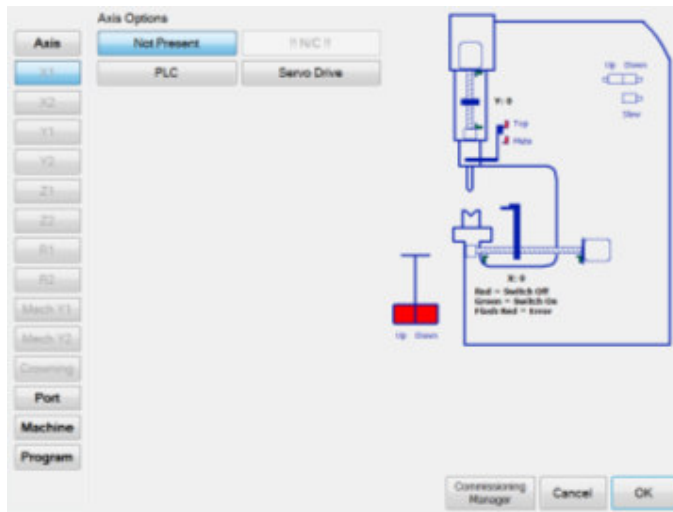

The settings screen allows the operator to change the how the pressbrake and all of the axes operate.

To open the settings screen press calibrate on the main screen and enter the password on the keypad displayed.

The different sections are displayed down the left hand side, the main sections are Axis, Port, Machine, and Program.

On the right is a diagram of the machine, showing the states of various switches attached.

Accepting or cancelling changes is done in the bottom left corner, this is also when you can access the Commissioning Manager.

### Axis:

The axis section controls the settings for each axis on the machine. Each axis can either be controlled by the plc or a servo drive, or it can be not present on the machine at all.

### Port:

The port section controls how the PLC and servo drives communicate with the Program. Some machines may have different devices on different ports. Check with your supplier or CNC Auto to verify these settings.

### Machine:

The settings that belong to the machine rather than a specific axis appear in this section.

### Program:

The settings that belong to the program rather than the machine appear in this section.

## 27. Calibrating the Port

Most of these settings will already be set up for you or given to you by your supplier.

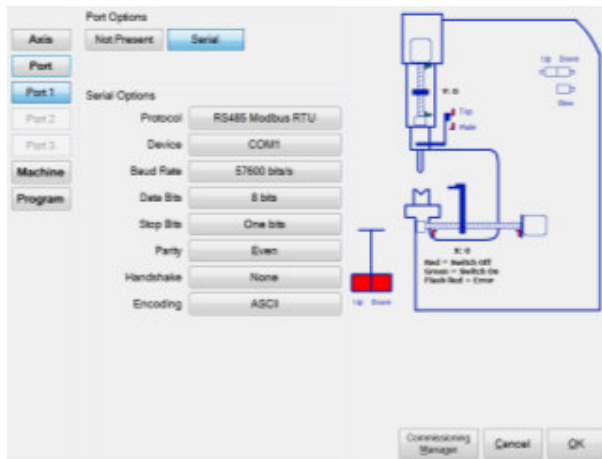

A port can either be Not Present or a Serial port, which can be selected from the top of the screen. This applies to the port selected in the Ports section.

### Protocol:

The protocol defines the way the PLC and Servo Drives communicate with the PC. The options for the protocol are: RS485 RTU (default), RS485 ASCII, and RS232 ASCII.

*Note: RS232 ASCII only supports one PLC or Servo Drive.*

### Device:

The device specifies the physical port the PLC and Servo Drives are connected to.

### Baud Rate:

The Baud Rate specifies the speed of communication on the COM port, measured in bps (bits per second).

### Data Bits:

The number of data bits for communications. Options are: 5, 6, 7, and 8 (default).

### Stop Bits:

The number of data bits for communications. Options are: 0, 1 (default), 1.5, and 2.

### Parity:

The parity for communications error checking. Options are: None, Odd, Even (default), Mark, Space.

*Note: None, Mark, and Space options do not check for errors.*

### Handshake:

The Handshaking for communications. Options are: None (default), X on / X off, Request to send, Both.

### Encoding:

The encoding for communications. Options are: None, Odd, Even (default), Mark, Space.

## 28. Calibrate Servo Drives

The Servo Drive option can be selected on the top of the screen when an axis is selected in the Axis.

### Port:

This is the port that the PC will use to communicate with the Servo, to setup the port see the Calibrating Ports help file.

### Address:

This is the address that is assigned to the servo, to distinguish it from the other Servo Drives or PLCs on the same port.

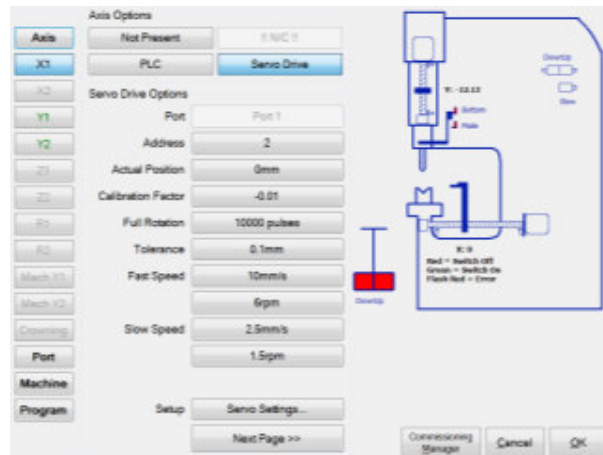

### Actual Position:

This is the position that the Axis connected to the servo drive is currently at (measured in mm).

### Calibration Factor:

This is the factor used to convert from the Servo Drives encoder pulses to an actual measurement (mm per pulse).

### Full Rotation:

The number of encoder pulses in a full rotation of the Servo Motor.

### Tolerance:

This is the tolerance of the measurement from the Servo Drive.

### Fast Speed:

This is the speed the Servo Motor moves at provided it is not close to the target.

### Slow Speed:

This is the speed the Servo Motor moves at when it is close to the target.

### Servo Settings:

This is used to set up the Servo Drives with defaults from Fasfold.

*Note: Each of these options requires the Servo Drive be reset (turned off and then on) to take effect.*

*Note: It is recommended that you complete the operations in this order.*

### Factory Defaults:

This option resets the Servo Drive to the Factory Default settings.



**Setup Comms:**

This will use the given Comms details to set the Servo Drives to use the Comms details specified in the Calibrate Ports screen.

*Note: This will send messages on the port using the settings specified here.*

**Upload Defaults:**

This sends the Fasfold specific default settings to the Servo Drive.

**Change Address:**

This changes the Servo Drive on the specified address to the Address on the Calibrate Servo Drive screen.

**Next/Previous Page:**

There is more than 1 page of settings for Servo Drives, this moves between the pages.

**Home Position:**

This specifies if the Home Position is High or Low, or if the Axis does not Home.

**Maximum/ Minimum Position:**

This specifies the Maximum/Minimum Position of the Axis.

**Limit Switches:**

Switches between the Limit Switches being Normally Open or Normally Closed.

**Slow Distance:**

The distance from the target to use the slow speed for.

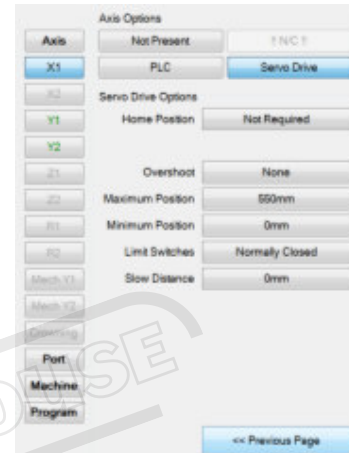

## 29. Calibrate PLC

The axis can be set as a PLC axis at the top of the screen, when an axis is selected in the Axis section on the right.

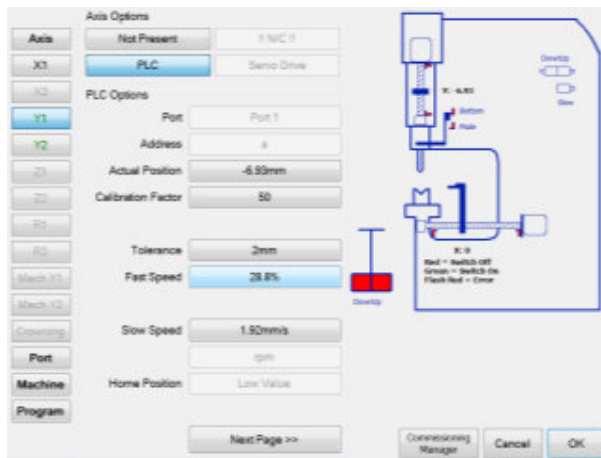

### Port:

This is the port that will be used for communication between the PC and the PLC.

### Address:

This is the address of the PLC.

### Actual Position:

This is the position of the axis (in mm).

### Calibration factor:

This is a factor to scale the encoder or linear slide pulses.

### Tolerance:

The tolerance is used to compare if two values are close enough to be the same (in mm).

### Fast Speed:

The speed that the beam goes down, until it is close enough to use the slow speed (in % max speed).

### Slow Speed:

The Slow Speed is the speed of the beam when it is close enough to the material (in mm/s).

### Home Position:

The Home Position indicates if the home position of the beam is a high value or low value.

### Next Page:

Cycles through the pages of settings for the PLC.

### Top/Bottom Position:

This is the position above/below which it considers the Pressbrake to be open (in mm).

### Slow Distance:

The distance from the material that will use the Slow Speed rather than the Fast Speed (in mm).

### Bend Distance:

The distance from the material that will use the Bend Speed rather than the Slow or Fast Speed (in mm).

### Bend Speed:

The Bend Speed is the speed of the beam when it is close enough to the material (in mm/s).



### Up/Down Speed:

The UP/Down speed is the speed at which the beam returns from bending to the open position (in % max speed).

### Slow Ramp:

The distance used to change from one speed to another (in mm).

### Maximum/Minimum Position:

The Maximum/Minimum Positions are the limits on the position of the beam (in mm).

### Dummy Position:

This is a secondary Top/Bottom Position used to speed up the Pressbrake (in mm).

### Easy Calibrate:

This allows calibration of the position by bending a test piece, and entering the difference.

### Quick Calibrate:

This is a wizard to troubleshoot problems with the Y axis, and corrects the offset once the settings are verified.

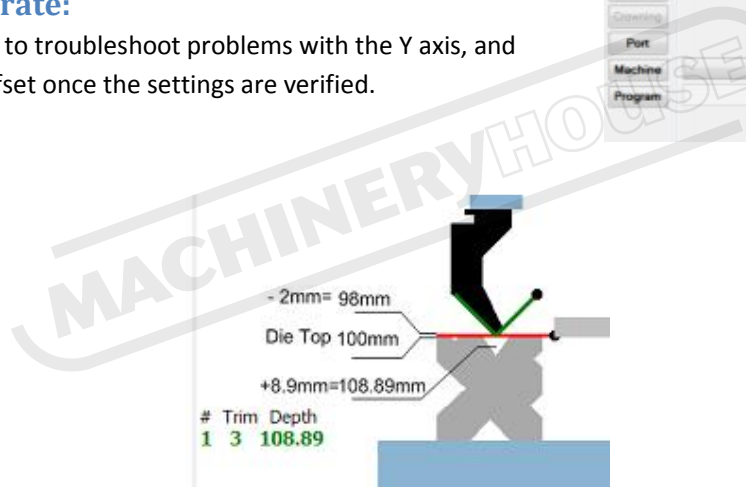
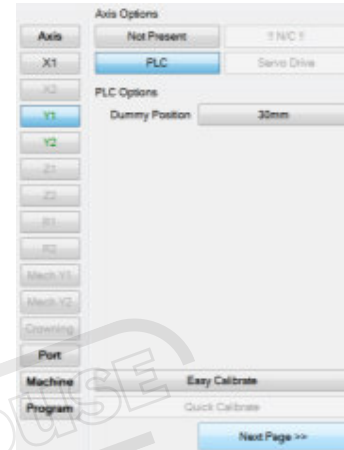

### 30. Calibrate Machine

The machine settings are settings that apply to the whole machine, not just a specific axis.

These settings can be accessed from the Machine section on the left hand side.

#### Dwell Time:

This is the time the beam must sit at the bending position before being allowed to open (in s).

#### Return Time:

This is the time the beam sits at the bending position, before the auto return (if enabled) will bring the beam up (in s).

#### Tonnage:

This is the rated tonnage of the machine (measure in t).

#### Tonnage Offset:

This is the pressure needed to apply 0t of force to the material (measured in %).

#### Crowning:

This is the amount the distance between the top and bottom varies with the force being applied (in mm/100t).

#### Crowning Max:

This is the upper limit on the crowning value (in mm/100t).

#### Crowning Offset:

This is the offset applied to the crowning value (in mm/100t).

#### Top/Bottom Switch:

If the Top/Bottom Switch is connected to one of the Servo Drives, this is the address of that Drive.

#### Up/Down Ramp Up:

This is the acceleration time for the beam as it moves to the open position (in s).

#### Up/Down Ramp Down:

This is the deceleration time for the beam as it moves to the open position (in s).

#### Stroke Type:

The Stroke Type indicates if the Pressbrake is a down-stroke machine (the tool moves down for the bend), or an up-stroke machine (the die moves up for the bend).

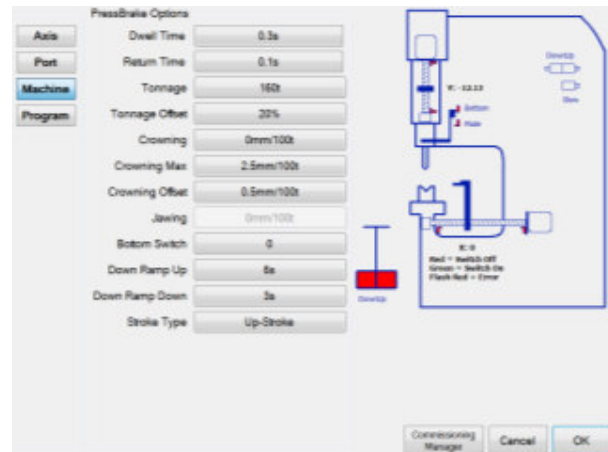

## 31. Calibrate Program

# Calibrating the Program

The settings that are specific to the program, but do not affect the machine are found in the Program section on the left side of the screen.

### Language:

This allows you to set the language of the machine.

Note: It is best to restart Fasfold after setting this.

### User Login:

This allows you to have multiple different users of Fasfold, providing each user a directory to store their tools, dies, and jobs.

### Backup Path:

This is a path to copy a backup of Fasfold settings and files should something go wrong with the PC.

Note: It is best if this path is removable or remote, such as a USB drive or a network location.

### Sort Files:

The sort files toggles between sorting files by date or alphabetically.

### Max Perms:

This is the number of checks for automatically calculating the bend sequence, a higher number gives more chance of success at the cost of speed.

### Clock Position:

This changes the position of the clock, and if it is visible at all.

